



Zoom

young For the explorers

A first look
at the new
2023-2024 catalogue

Jambette.com



VT-21000-5B



New in 2022

VOLTE

AGE GROUP
5 to 12 years

CAPACITY
40 children

CSA AND ASTM FALL HEIGHT
13' 4" / 4.1 m

SURFACE AREA REQUIRED
25' x 24' / 7.6 m x 7.3 m

The super climber scaling up the challenges!

Volte is a super climber offering a wide range of possibilities to young adventurers who want to climb, hang or simply feel the wind on their faces.

Up to 40 children can play on the remarkably versatile Volte. Featuring a unique design, the module can be installed on its own on a playground, combined or completed with additional components for extra challenges, or integrated into a psychomotor module for added exclusive climbing features.

! Based on the CAN/CSA-Z614 standard, installation on a cushioning surface and compliance with clearance distances are required.

Citiplex

A modern, playful and creative tower for children eager for new challenges.

A scalable and inclusive urban play module, Citiplex includes accessories and games integrated into its bottom section and under its platforms for individuals with impaired mobility.

The dream cabin is taken to a whole new level, where imagination has no limits!

! Based on the CAN/CSA-Z614 standard, installation on a cushioning surface and compliance with clearance distances are required.

Climb the interior walls of the tower, go through the labyrinth game, hurtle down its slopes and hop on its massive slide.

Discover unique spaces: some are interactive with exciting games integrated right into the structure, while others are roomier spaces where children can chill out and enjoy a spectacular view of the surroundings. This is what the Citiplex experience is all about!



Volte combined with two new J2 elements

VT-21001-5B



Volte integrated into a psychomotor module

M-21101-HB

Citiplex CX-19002-5B

Citiplex is unique with many innovative materials. Down the road, several units could be combined to create a mini-city. The dream cabin is taken to a whole new level, where imagination has no limits!

AGE GROUP
5 to 12 years

CAPACITY
91 children

SURFACE AREA REQUIRED
74' x 47' / 22.6 m x 14.3 m

CSA AND ASTM FALL HEIGHT
12' / 3.7 m



Offbeat modular structures



J2-20010-5B



J2-22000-5B

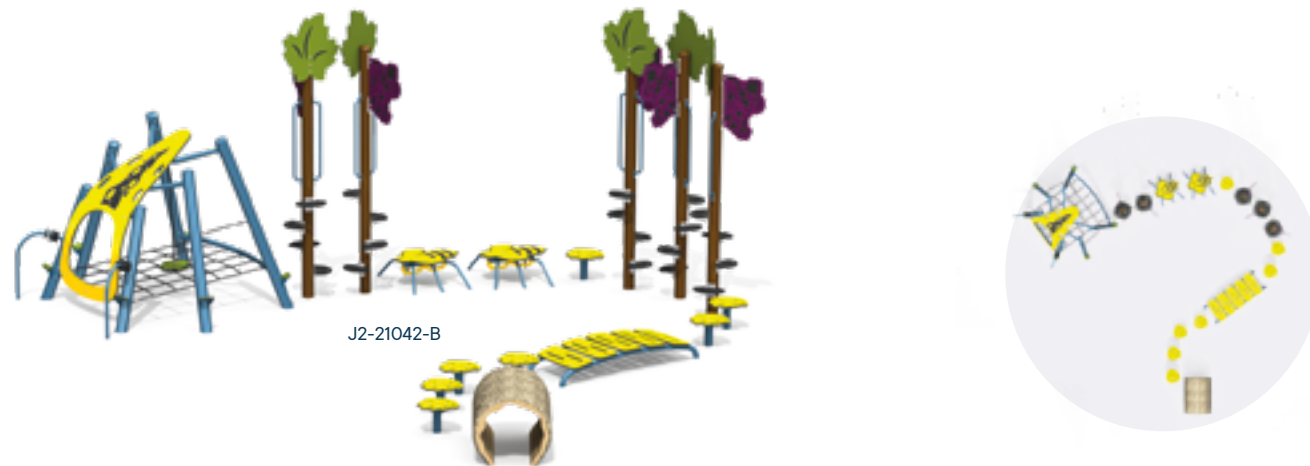

J2-21042-B



J6-21004-5B



J6-20006-5B



J6-18004-5B

Psychomotor courses

MODEL	AGE GROUP	CAPACITY	SURFACE AREA REQUIRED	CSA AND ASTM FALL HEIGHT
J2-20010-5B	18 months to 12 years	36 children	47' x 24' / 14.3 m x 7.3 m	5' 5" / 1.6 m
J2-22000-5B	5 to 12 years	62 children	72' x 32' / 21.9 m x 9.8 m	9' 6" / 2.8 m
J2-21042-B	18 months to 5 years	40 children	39' x 36' / 11.8 m x 10.9 m	6' 4" / 1.9 m

Manta circuits

MODEL	AGE GROUP	CAPACITY	SURFACE AREA REQUIRED	CSA AND ASTM FALL HEIGHT
J6-21004-5B	5 to 12 years	82 children	38' x 31' / 11.5 m x 9.4 m	13' / 3.9 m
J6-20006-5B	18 months to 12 years	40 children	34' x 21' / 10.3 m x 6.4 m	7' 8" / 2.3 m
J6-18004-5B	18 months to 5 years	35 children	34' x 22' / 10.3 m x 6.7 m	6' 2" / 1.8 m

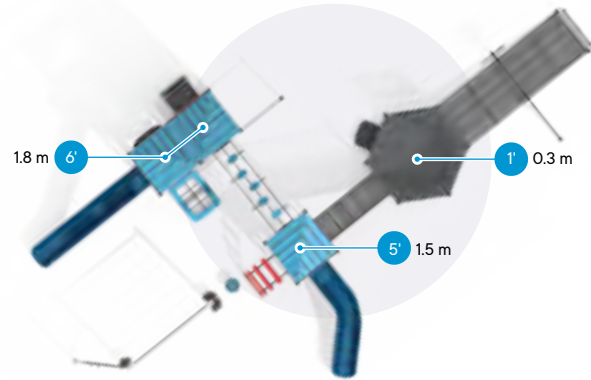

M-22079-HB

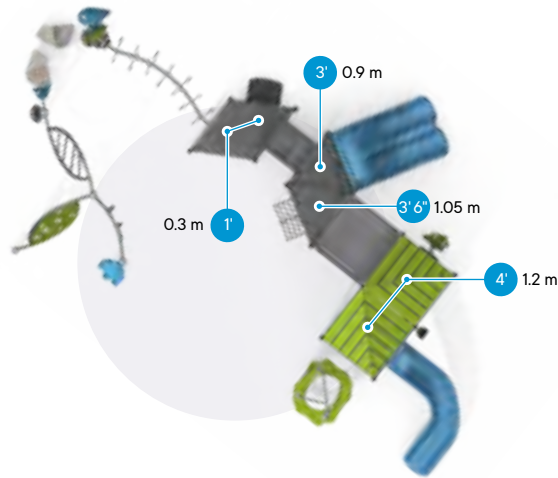

M-22083-HB



J3-22255-HB

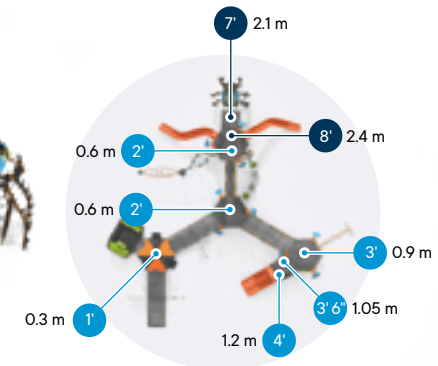

J3-22152-5HB

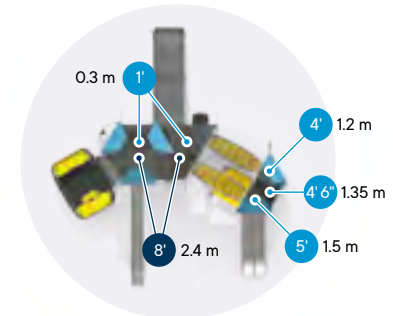

J3-22270-HA

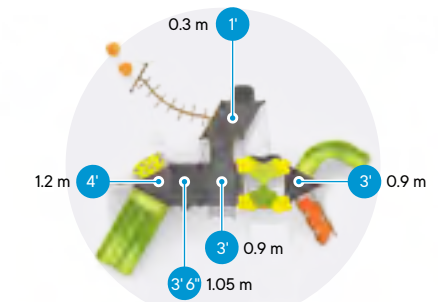

J3-22253-HA

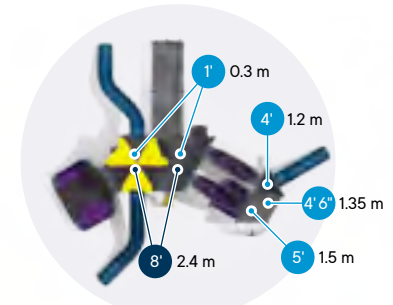

● Top platform heights
● Bottom platform heights

Playful M spaces

MODEL	AGE GROUP	CAPACITY	SURFACE AREA REQUIRED	CSA FALL HEIGHT	ASTM FALL HEIGHT
M-22079-HB	5 to 12 years	58 children	53' x 37' / 16.2 m x 11.3 m	9' 2" / 2.8 m	7' 9" / 2.4 m
M-22083-HB	18 months to 5 years	62 children	48' x 35' / 14.6 m x 10.7 m	7' 2" / 2.2 m	5' 11" / 1.8 m

J3 psychomotor blocks

MODEL	AGE GROUP	CAPACITY	SURFACE AREA REQUIRED	CSA FALL HEIGHT	ASTM FALL HEIGHT
J3-22255-HB	5 to 12 years	179 children	68' x 32' / 20.7 m x 9.8 m	11' 2" / 3.4 m	10' 4" / 3.1 m
J3-22152-5HB	5 to 12 years	99 children	48' x 45' / 14.6 m x 13.7 m	11' 2" / 3.4 m	10' 8" / 3.3 m
J3-22270-HA	18 months to 5 years	44 children	38' x 35' / 11.6 m x 10.7 m	7' 2" / 2.2 m	5' 11" / 1.8 m
J3-22253-HA	18 months to 12 years	98 children	50' x 47' / 15.2 m x 14.3 m	11' 2" / 3.4 m	8' 0" / 2.4 m



G-22007 (3')

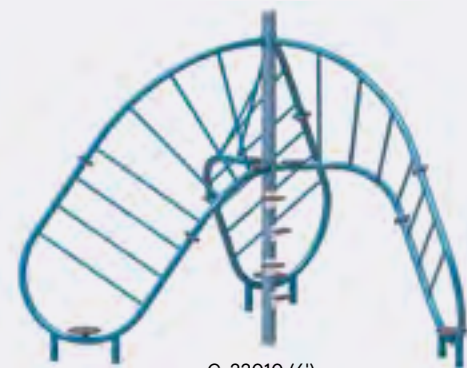

G-22010 (6')



G-22008 (4')

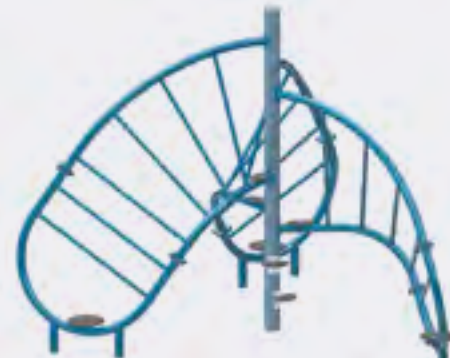

G-22011 (3', 4', 5')



G-22009 (5')

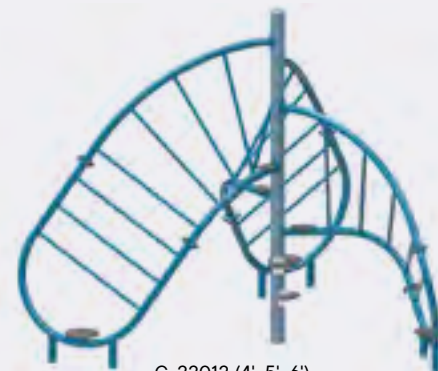

G-22012 (4', 5', 6')



New in 2022

Twist Climber

Legs, hips and arms are going to be a twistin' at the playground this summer!

The brand-new multifunctional **Twist** climber is the ideal equipment for developing coordination and physical strength. It can be set up on its own or combined with a play module.

MODEL	TYPE	AGE GROUP	CAPACITY	SURFACE AREA REQUIRED	CSA AND ASTM FALL HEIGHT
G-22007	Independent	18 months to 12 years	7 children	24' x 24' / 7.3 m x 7.3 m	3' 0" / 0.9 m
G-22008	Independent	18 months to 12 years	7 children	24' x 24' / 7.3 m x 7.3 m	3' 6" / 1.1 m
G-22009	Independent	18 months to 12 years	10 children	25' x 25' / 7.6 m x 7.6 m	4' 6" / 1.4 m
G-22010	Independent	18 months to 12 years	10 children	26' x 26' / 7.9 m x 7.9 m	5' 6" / 1.7 m
G-22011	Independent	18 months to 12 years	8 children	26' x 25' / 7.9 m x 7.6 m	4' 6" / 1.4 m
G-22012	Independent	18 months to 12 years	9 children	26' x 26' / 7.9 m x 7.9 m	5' 6" / 1.7 m



L-21083-A

New in 2022

Sensory Tunnel

Enjoy a special sensory experience with this playground equipment!

Go through the tunnel and discover a world of colours and textures that build handling skills and dexterity, in a calm and secure setting. Jambette's Sensory Tunnel is a small world of its own, where discovery of the senses and communication is encouraged while ensuring inclusion through easy access for wheelchairs and other children's mobility aids.

This logo identifies products that are wheelchair accessible in accordance with Appendix H of the CAN/CSA-Z614 standard and the Americans with Disabilities Act Accessibility Guidelines (ADAAG).



L-22000-A

MODEL	TYPE	AGE GROUP	CAPACITY
L-22000-A / L-22000-B	Short	18 months to 12 years	5 children
L-21083-A / L-21083-B	Double	18 months to 12 years	10 children
L-22001-A / L-22001-B	Double	18 months to 12 years	10 children



Tunnel without flexible partial walls for wheelchair access (L-22001-A and L-22001-B)



L-22001-A

leaf hideaway

Leaf hideaway

New in 2022

A world of foliage and fun!

Welcome to the leaf hideaway, a world where exploration, communication, mutual support and wonder come together!

This set of leaves is designed to serve as shelter, seat or balancing structure. Children can enjoy hiding, climbing, sitting and hopping from one leaf to another.

Below are some potential layouts of the leaf components.

MODEL	AGE GROUP	CAPACITY	SURFACE AREA REQUIRED	CSA AND ASTM FALL HEIGHT
G-21012	18 months to 12 years	3 children	19' x 16' / 5.8 m x 4.9 m	2'7" / 0.8 m
G-21013	18 months to 12 years	4 children	19' x 16' / 5.8 m x 4.9 m	2'11" / 0.9 m
G-21014	18 months to 12 years	4 children	20' x 17' / 6.1 m x 5.2 m	3'7" / 1.1 m
G-21015	18 months to 12 years	3 children	19' x 16' / 5.8 m x 4.9 m	2'0" / 0.6 m
G-21016	18 months to 12 years	3 children	19' x 16' / 5.8 m x 4.9 m	3'0" / 0.9 m
G-21017	18 months to 12 years	1 child	17' x 16' / 5.2 m x 4.9 m	6'7" / 2 m
G-21018	18 months to 12 years	2 children	16' x 15' / 4.9 m x 4.6 m	3'0" / 0.9 m
G-21019	18 months to 12 years	1 child	14' x 13' / 4.3 m x 4 m	1'0" / 0.3 m
J5-21000-5B	18 months to 12 years	11 children	25' x 21' / 7.6 m x 6.4 m	3'7" / 1.1 m
J5-21001-5B	18 months to 12 years	15 children	26' x 23' / 7.9 m x 7 m	6'7" / 2 m
J5-21005-5B	18 months to 12 years	13 children	29' x 21' / 8.8 m x 6.4 m	3'7" / 1.1 m



G-21012



G-21013



G-21014



G-21015



G-21016



G-21017



G-21018



G-21019



J5-21000-5B



J5-21001-5B



J5-21005-5B



ACCESSIBLE TRIPLE MONKEY BARS

Model	Age group	Capacity	Surface area required	ASTM Fall height
Z-21001	13+ years	3	21' x 17' / 6.4 m x 5.2 m	5'7" / 1.7 m

This device is designed for use from a wheelchair. It helps to develop cardiovascular endurance. It tones and supports mobility of the lower limbs (buttocks, thighs and calves).



ACCESSIBLE OVERHEAD LADDER

Model	Age group	Capacity	Surface area required	ASTM Fall height
Z-21006	13+ years	2	27' x 16' / 8.2 m x 4.9 m	5'2" / 1.6 m

The versatile and classic overhead ladder is great for performing a range of upper body exercises. Slightly oversized, it provides the clearance needed for adults to exercise comfortably. In an obstacle course layout, the overhead ladder helps to strengthen movement coordination.

Fyzik

JAMBETTE

New in 2022 – Accessible Fyzik products

Help your adult clientele get fit with an outdoor fitness circuit.

- Equipment comes with quality signs explaining the exercises to be performed, including repetitions and duration
- Equipment made of Canadian aluminum, heavy duty steel and stainless steel hardware
- Custom circuit design available

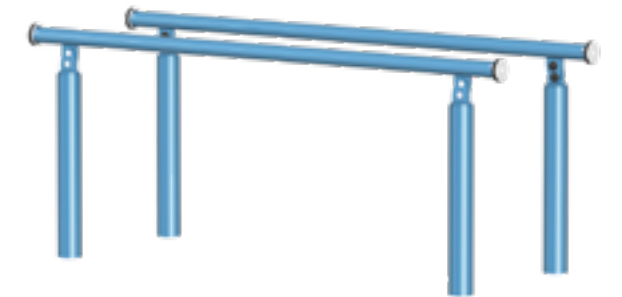

ACCESSIBLE PARALLEL BARS

Model	Age group	Capacity	Surface area required	ASTM Fall height
Z-21005	13+ years	1	19' x 15' / 5.8 m x 4.6 m	2'11" / 0.89 m

These bars are a must on a fitness circuit. Designed to strengthen the triceps, the exercises can be adapted to work on other parts of the body.



ACCESSIBLE DOUBLE RING LADDER

Model	Age group	Capacity	Surface area required	ASTM Fall height
Z-21007	13+ years	2	25' x 17' / 7.6 m x 5.2 m	5'2" / 1.6 m

Rings are a challenge for most people. This equipment is a very interactive addition to any fitness circuit. Rings are great for improving movement coordination and increasing upper body strength. A range of exercises can be performed to strengthen the upper body muscles.



L-21027-5AB

New in 2022

The Gondola

Children will enjoy a very exciting sensory experience with this park equipment!

This platform rocks from right to left and provides all the space needed for two wheelchair users.

The space lends to stimulating socialization for children with impaired mobility.

The Gondola can also be part of a complete play module (see J3-22116-5HA, for example).



J3-22116-5HA

The Gondola

MODEL	AGE GROUP	CAPACITY	SURFACE AREA REQUIRED	CSA AND ASTM FALL HEIGHT
L-21027-5AB	18 months to 12 years	13 children	33' x 23' / 10.1 m x 7 m	3' 6" / 1.1 m

 This logo identifies products that are wheelchair accessible in accordance with Appendix H of the CAN/CSA-Z614 standard and the Americans with Disabilities Act Accessibility Guidelines (ADAAG).

 Based on the CAN/CSA-Z614 standard, installation on a cushioning surface and compliance with clearance distances are required.



The accessible wheelchair swing set

Being able to swing in your own wheelchair is a unique and amazing experience to enjoy.

The swinging movement helps to develop the inner ear and one's sense of balance. A self-propulsion system helps users develop their autonomy. Equipped with a stabilization mechanism to easily get on and off, this swing set has many features that make it safe, hard-wearing and efficient. Capacity of 1588 kg (3 500 lbs.)



The accessible wheelchair swing set

MODEL	CAPACITY	SURFACE AREA REQUIRED	CSA AND ASTM FALL HEIGHT
L-19086	1 child	19' x 17' / 5.8 m x 5.2 m	8' 8" / 2.7 m

 This logo identifies products that are wheelchair accessible in accordance with Appendix H of the CAN/CSA-Z614 standard and the Americans with Disabilities Act Accessibility Guidelines (ADAAG).

 Based on the CAN/CSA-Z614 standard, installation on a cushioning surface and compliance with clearance distances are required.



Nin-Ka Parkours

New in 2022

nin·ka

Agility, speed and fun!

Put your skills to the test with our brand-new Parkours products for children aged 5 to 12.

Get ready to run, jump and crawl!

Grab onto the modules using the rings, the handle and the other course components.

The Nin-Ka line of products offers a range of obstacles for maximum fun!

MODEL	AGE GROUP	CAPACITY	SURFACE AREA REQUIRED	CSA AND ASTM FALL HEIGHT
K-22000	5 to 12 years	3 children	20' x 17' / 6.1 m x 5.2 m	2' 3" / 0.7 m
K-22001	5 to 12 years	3 children	21' x 16' / 6.4 m x 4.9 m	1' 3" / 0.4 m
K-22002	5 to 12 years	5 children	23' x 14' / 7 m x 4.3 m	7' 9" / 2.4 m
K-22003	5 to 12 years	5 children	23' x 18' / 7 m x 5.5 m	9' 3" / 2.8 m
K-22004	5 to 12 years	3 children	15' x 13' / 4.6 m x 4 m	9' 1" / 2.8 m
K-22005	5 to 12 years	8 children	24' x 23' / 7.3 m x 7 m	8' 9" / 2.7 m
K-22006	5 to 12 years	5 children	23' x 13' / 7 m x 4 m	9' 3" / 2.8 m
K-22007	5 to 12 years	10 children	30' x 17' / 9.1 m x 5.2 m	7' 1" / 2.2 m
K-22008	5 to 12 years	5 children	21' x 17' / 6.4 m x 5.2 m	7' 1" / 2.2 m
K-22009	5 to 12 years	5 children	21' x 17' / 6.4 m x 5.2 m	6' 6" / 2 m
K-22010	5 to 12 years	1 child	17' x 16' / 5.2 m x 4.9 m	1' 1" / 0.3 m
K-22011	5 to 12 years	1 child	18' x 13' / 5.5 m x 4 m	3' 0" / 0.9 m
K-22012	5 to 12 years	3 children	22' x 21' / 6.7 m x 6.4 m	9' 3" / 2.8 m
K-22013	5 to 12 years	2 children	21' x 19' / 6.4 m x 5.8 m	7' 7" / 2.3 m
K-22014	5 to 12 years	2 children	22' x 17' / 6.7 m x 5.2 m	7' 7" / 2.3 m
K-22016	5 to 12 years	2 children	18' x 13' / 5.5 m x 4 m	1' 3" / 0.4 m
K-22017	5 to 12 years	3 children	25' x 13' / 7.6 m x 4 m	5' 6" / 1.7 m
K-22018	5 to 12 years	2 children	21' x 16' / 6.4 m x 4.9 m	2' 6" / 0.8 m



K-22006



K-22007



K-22008



K-22009



K-22010



K-22011



K-22012



K-22013



K-22014



K-22016



K-22017



K-22018



K-22000

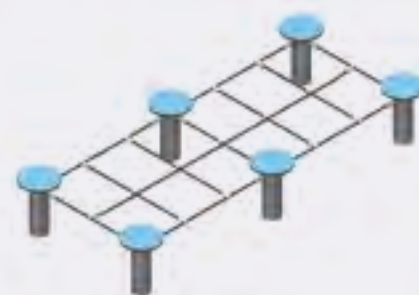

K-22001



K-22002



K-22003

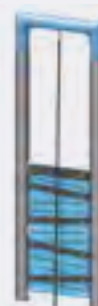

K-22004



K-22005

The Silla-2 Rocker

Upright spring module, two-seater model

A truly original rocker! The central axle and springs ensure stable movement, so there is no need for ground shock absorbers. The cradle seats of this rocker are designed to support the body, ensuring the safety of users with impaired mobility.

New in 2022

The Silla-2 Rocker • L-21078

AGE GROUP	CAPACITY	SURFACE AREA REQUIRED	CSA AND ASTM FALL HEIGHT
18 months to 12 years	2 children	21' x 15' / 6.4 m x 4.6 m	1' 6" / 0.5 m





This outdoor space fitted to your needs will quickly become a favourite place for teachers and students to gather. Moreover, it will provide an opportunity to integrate nature into your school setting. This interactive space serves as a multipurpose teaching environment, tailored to meet children's specific learning needs.

New in 2022 • The Whiteboard

The Outdoor Classroom

With this board, students can enjoy class time outdoors. Like a conventional whiteboard, its surface finish is suitable for use with dry-erase markers. The two locking doors provide storage space on one side and an additional surface for drawing on the other!



A-22001 - Open panels, front view



A-22001 - Open panels, back view



A-22002 - Back view



A-22001 - Closed panels, front view



A-22001 - Closed panels, back view



A-22002 - Front view

My free play

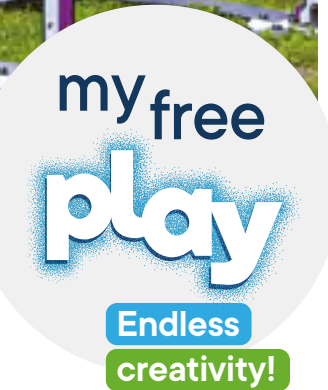

MY FREE PLAY modules: a new signature concept by Jambette.

This play area offers a range of activities to get children moving; it supports their physical and social development, while stimulating another dimension — CREATIVITY.

There are countless benefits for the children, as free play promotes their psychological, intellectual and motor development by learning about:

- Imagination and creativity
- The control of emotions
- Autonomy and problem-solving
- Self-esteem

Included:

- Frame delivered in separate parts
- Stainless steel assembly hardware
- Plastic containers
- Seals
- Oversized nuts and bolts
- Assortment of polyethylene panels to be assembled in countless ways
- Ropes of various lengths
- Tarp
- Flattened cardboard boxes
- Timber of various lengths



My free play original and My free play mini

MODEL	AGE GROUP	CAPACITY	SURFACE AREA REQUIRED
JL-20001 My free play mini	18 months to 12 years	5 children	14' x 14' / 4.3 m x 4.3 m
JL-20000 My free play original	18 months to 12 years	12 children	18' x 18' / 5.5 m x 5.5 m

This logo identifies products that are wheelchair accessible in accordance with Appendix H of the CAN/CSA-Z614 standard and the Americans with Disabilities Act Accessibility Guidelines (ADAAG).



The Echo Baby Seat

S-21001

This is a swing seat for two young children to enjoy special moments of closeness.

It must be installed on its own bay in a swing set of 8' or over.



The Echo Seat

S-19001

Being able to swing face to face with your child is definitely an uplifting, inclusive activity. Maintaining eye contact with the child ensures a safer, enjoyable activity.

This is a swing seat in which a young child and an adult or a young child and an older child can enjoy special moments of closeness.

- Can support the weight of one adult and one child
- Must be installed on its own bay in a swing set of 8' or over



L-20028 French front-back

The non-verbal communication board

Some children need more structured support to function. Using pictograms helps them organize their activities at the playground. When they feel more comfortable and happier, they can better enjoy their favourite leisure activities.

Available in several languages:

Panel width: 6'2" / 1.89 m

L-20021 English front-back

L-20028 French front-back

L-20029 French front, English back

New in 2022

L-21070 English front, Spanish back

 This logo identifies products that are wheelchair accessible in accordance with Appendix H of the CAN/CSA-Z614 standard and the Americans with Disabilities Act Accessibility Guidelines (ADAAG).



For information about our warranties:
jambette.com/en/services/warranty

Jambette.COM

700, rue des Calfats
Lévis, Québec
G6Y 9E6
Canada

Tel.: 418 837-8246
Toll-free: 1 877 363-2687
Fax: 418 837-2916

jambette.com

We reserve the right to change the design and features of our products and the specifics of our services and warranties without prior notice.

RBQ LICENCE: 8330-7280-51



MADE IN CANADA



This logo identifies products that are wheelchair accessible in accordance with Appendix H of the CAN/CSA-Z614 standard and the Americans with Disabilities Act Accessibility Guidelines (ADAAG).



To verify product certification, visit www.ipema.org



To verify product certification, visit www.ipema.org



Bissonnette
Communications
Impact

bisscomm.com

The International Play Equipment Manufacturers Association (IPEMA) provides third-party certification to ensure public play equipment and surfacing material product conformance to specific ASTM and/or CSA standards. Each product promoted in this flyer, if certified by IPEMA, includes the name and model number for you to search the IPEMA website for verification.

To verify product certification, visit www.ipema.org and conduct a search.

PRINTED IN CANADA